

Technical Data

Specifications (Max. values at 23°C, unless otherwise stated)

General	D	Unit
Conversion error (linearity) ¹	0.02	%
Temperature drift	100	ppm/K
Output impedance, typ.	600	Ohm
Output amplitude, typ. ²	5-24	V
Influence power supply	0.02	%/V

¹ 10 kHz range

² Depends on voltage level at enable input terminal. For a load of 1 kOhm and an enable voltage of 24 V the output amplitude is approx. 15 V.

Temperature range	°C
recommended	0/60
funktional	-20/90

Accuracy Frequency Output

Base error max. 0.2% (including conversion error, calibration error and temp. drift 20-30°C). Factory setting: 5 kHz output frequency. Typical error for other ranges (using range switches): 1% (max. 4% 100, 200, 400 and 800 Hz).

Input

Current input: DC-currents from uA to 100 mA, input impedance ca. 100 Ohm (20 mA range)

Voltage input: standard up to 30 VDC, also neg. values.. On request up to 100 VDC. Input impedance typ. 330 kOhm

Pt-100/resistances: 2-, 3- or 4-wire connection. Sensor current (Pt-100): ca. 0.5 mA. All ranges, also for Pt-500/1000, Ni, Cu.

Thermocouples: all types and all ranges

Overvoltage protection up to 30 VDC (self resetting fuse), surge/burst protection up to 3 kV.

Ausgang (Frequenz)

Without Optocoupler: up to 20kHz output frequency, rise/fall time typ. 10 us, pulse width min. 80 us, for <5kHz: duty cycle 1:1.

The output is short circuit proof and secure against overvoltage (up to 30 VDC).

With Optocoupler: max. Frequency is 10k Hz. Fall time typ 50 us.

Please note, that the voltage at the enable input (terminal 3) determines the output voltage (minus voltage drops in protection elements). A ripple at the enable input also appears on the output "high"-level.

Power Supply

All modules are suited for unregulated, noisy industrial power supplies; nominal value is 24 VDC (min. 18 V, max. 30 V). Consult factory for other voltages.

Options

3-port-isolation with DC-DC-converter (integrated in the module) for 24 V power supply. Test voltage 1 kV

Adjustable limit switch GW1 (integrated). Details see separate data sheet.

Other ranges, other time constants etc.

When ordering, please specify

Module type, input type (voltage, current, Pt-100, TE...)

Input and output range (input in V, mV, mA, Ohm or °C, output in Hz). This information is only needed if the transmitter has to be factory calibrated to a specific range (free of charge for one range).

Supply voltage: standard is 24 V, others on request

Options

Connections (DIN-Rail Housing)

- 1: Supply + (24 V DC)
- 2: Supply - (24 V DC), Ground
- 3: Enable input (5 -30 V)
- 4: Frequency output, 1-5kOhm load to ground, enable level equal output level minus protection voltage drops

Version for current, voltage

- 5: open
- 6: open
- 7: Input -
- 8: Input +

Version for thermocouples:

- 5: open
- 6: open
- 7: thermocouple -
- 8: thermocouple +

Version for resistors, Pt-100

- 5: Se-
- 6: So-
- 7: Se+
- 8: So+

Programming SMD-Switches

The range-switch is located inside the housing. In case of a housing without a window please remove the transparent plastic cover carefully, then the printed circuit board can be pulled out (pull the screw terminals).

The setting for the span is done using a binary code: just add the different values. Example: for a span of 5 kHz, the switches 2, 5 and 6 have to be „on“: 200 Hz + 1.6 kHz +3.2 kHz = 5 kHz.

Switch	off	on
1	0	100 Hz
2	0	200 Hz
3	0	400 Hz
4	0	800 Hz
5	0	1.6 kHz
6	0	3.2 kHz
7	0	6.4 kHz
8	0	12.8 kHz

Connecting a Thermocouple, a Current or a Voltage to a DIN-Rail Module

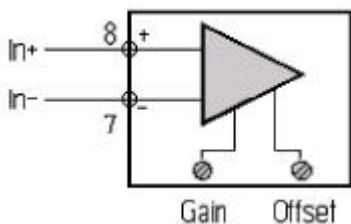

The built-in potentiometers for gain and offset have an adjustment range of ca. 5%

Connecting a Thermocouple, a Current or a Voltage to a Module for Printed Circuits

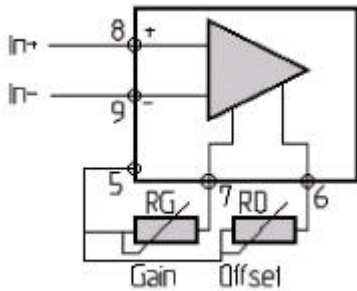

Nominal value for the external potentiometers: 1 kOhm

Connection of a Resistor/Pt-100 to a DIN-Rail Module

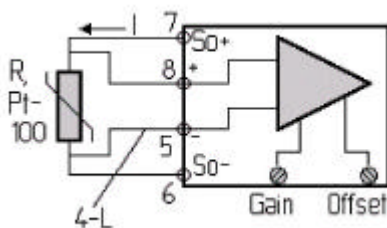

2L-connection: external short circuit between 5-6 and 7-8
3L-connection: terminal 5 not connected

Please note: A 3-wire connection can't be realized with a 4-wire module and vice versa.

Connection of a Resistor/Pt-100 to a Module for Printed Circuits

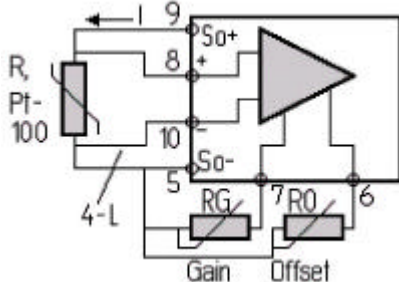

2L-connection: external short circuit between 5-10 and 9-8
3L-connection: terminal 10 not connected

Filter (2x51 Ohm, 1x100nF) to be used in case of HF-interferences

Please note: A 3-wire connection can't be realized with a 4-wire module and vice versa.

External Potentiometer: 1kOhm each, adjustment range approx. 5%

Frequency Output (with Enable)

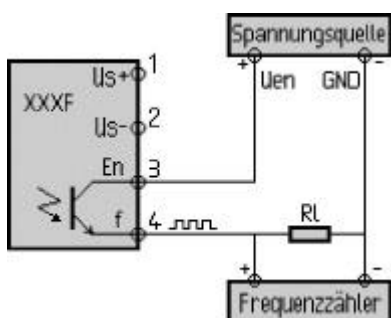

Terminal 1: Pos. power supply, 24 VDC nominal

Terminal 2: Power supply ground

Terminal 3: Enable input, 4-30 VDC, open or 0 V: no output (tristate)

Terminal 4: Frequency output (plus). This version needs a load resistor (RL) between 1kOhm and 5 kOhm to frequency counter ground.

The output high voltage is equal to the enable voltage minus voltage drops in protection elements (load dependent).

Isolation barrier (output-input-supply) is not allowed for mains (Vmax = 60 V)

Output Always Enabled

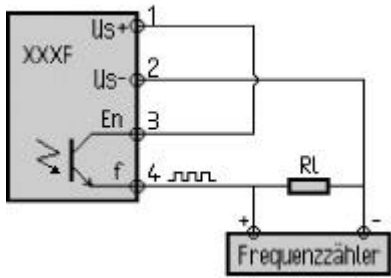

- Terminal 1: Pos. power supply, 24 VDC nominal
- Terminal 2: Power supply ground
- Terminal 3: Enable input connected to power supply (always enabled)
- Terminal 4: Frequency output (plus). This version needs a load resistor (RL) between 1Kohm and 5 kOhm to frequency counter ground.

Isolation barrier (output-input) is not allowed for mains (Vmax = 60 V)

Common Frequency Bus

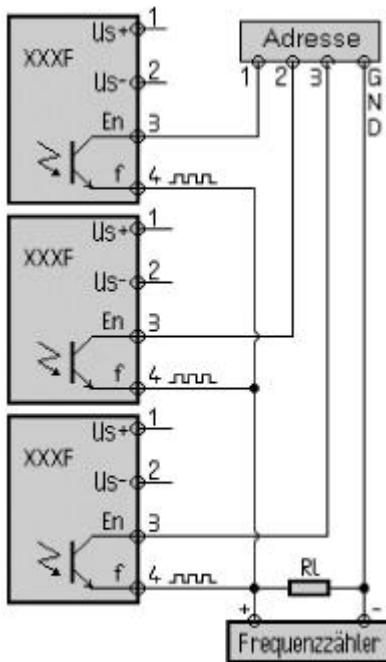

With this version, a bus can be realized. An address-generator (5-30 VDC) switches a module on and off. The output of all modules is connected to the same line. The output high voltage is equal to the enable voltage minus voltage drops in protection elements.

- Terminal 1: Pos. power supply, 24 VDC nominal
- Terminal 2: Power supply ground
- Terminal 3: Enable input, 4-30 VDC, open or 0 V: no output (tristate)
- Terminal 4: Frequency output (plus). This version needs a load resistor (RL) between 1Kohm and 5 kOhm to frequency counter ground.

Some hints about the value of the external load resistor RI:

For frequencies above 3 kHz the value should be between 1 and 3 kOhm (including the input impedance/cable impedance of frequency counter). The higher the value of RI, the higher the "low" voltage. Example for $f = 5 \text{ kHz}$, $U_{en} = 24 \text{ V}$ and $RI = 2 \text{ kOhm}$: U_{low} ca. 0.5 V, U_{high} ca. 18 V. For $f = 5 \text{ kHz}$, $U_{en} = 5 \text{ V}$ and $RI = 3 \text{ kOhm}$ one gets U_{low} ca. 1.2 V, $U_{high} = 3.6 \text{ V}$.

For frequencies above ca. 10 kHz we recommend 1 kOhm. For 20 kHz and $RI = 1 \text{ kOhm}$ one gets U_{low} ca. 1 V and U_{high} ca. 14 V.

Coaxial cables represent an additional load, resulting in reduced amplitude.

The enable input (terminal 3) needs a voltage between 4 and 30 V. An open input or 0 V disables the output (high impedance or tristate). The enable input voltage also determines the amplitude. The amplitude is reduced by the voltage drop in the protection elements (ca. 600 Ohm).

Adjustment of Measurement Range and Zero Point (Offset)

The modules with a fixed measurement range are precisely calibrated at the factory (error usually less than 0.05%), further calibration is generally unnecessary. If the output values are not correct, first of all check the connections, the power supply (is the supply voltage correct ?), the experimental arrangement and all instruments in use. We recommend that when working with programmable or configurable modules, the calibration should be checked after each new adjustment.

Adjustment is performed using a calibrator or a calibrated sensing device. The zero point (offset) is adjusted via the "Offs" potentiometer and the full scale value is adjusted via the "gain" potentiometer. The zero point is adjusted first and then the full scale. Where large adjustments are necessary, the procedure should be carried out several times. For additional reliability, the output value should be measured at half the measurement range (linearity test). The output of modules with a unipolar supply voltage can't reach exactly 0. In such cases, zero point adjustment must be performed with an input value which produces a non-zero output value.

Important note:

Soclair Electronics is continually working to improve the quality and reliability of its products. MTBF (using MIL217) is well above 10 years (in most cases even more than 100 years). Nevertheless, electronic devices in general can malfunction or fail due to their inherent physical and chemical properties. It is the responsibility of the buyer, when utilizing Soclair Electronic products, to observe standards of safety and to avoid a situation in which a malfunction or failure of a Soclair Electronic device could cause loss of human life, injuries or damage to properties. Soclair Electronic products are not authorized for use in life support systems.